



# Shower channels

## **Shower channels**

### ***Linearis Comfort***

Page **160 – 165**

Variety of different installation options - for an individual bathroom design

## **Shower channels**

### ***Linearis Compact***

Page **162 – 163**

Minimum installation height - ideal for flush-to-floor showers and bathroom renovation!

## **Shower channels**

### ***Linearis Super 60***

Page **166 – 172**

With tileable access cover - full access for maintenance and cleaning!

## **Shower channels**

### ***Linearis***

Extremely narrow channel - elegant appearance!

System 125

Page **166 – 169**

System 100

Page **170 – 172**



**SmartSelect** makes planning quite simply quicker - visit [smartselect.kessel.de](http://smartselect.kessel.de) for the configurator for alternative waterproofing layers in the system

# Linearis Comfort - designer shower channels



Ready-to-install complete channel with fix mounted drain body with lateral outlet or as channel for combination with System 125 bodies

## Shower channels *Linearis Comfort*

### OPTIMISED IN DESIGN AND FUNCTION

#### COMPLETE SHOWER CHANNELS

Ready-to-install complete shower channels with fix mounted drain body with lateral outlet, minimum overall installation height 93 mm. Flange installation height only 86 mm.

#### LENGTHS

Five channel lengths: 750, 850, 950, 1050 and 1150 mm.

#### FLEXIBILITY

Vertically adjustable frame can be adjusted from 7-22 mm to meet on-site tile thicknesses.

#### INDIVIDUAL

Attractive design covers also available with LED backlighting technology (Fig. 1). Stainless steel cover can be turned over and tiled to offer an "invisible" look. (Fig. 2).

#### SOUND PROTECTION

Measurements carried out by the Fraunhofer Institute in Stuttgart: shower channel *Linearis Comfort*

- $\geq 17$  dB(A) according to DIN 4109
- $\geq 13$  dB(A) according to VDI 4100 SST III

#### FIRE AND SMOKE PROTECTION

*Fire-Kit* fire and smoke protection insert and *Quick-Fit* passage seal including fire protection for drains with vertical outlet are optionally available.



*Linearis* shower channels for flush-to-floor installation are leading the modern bathroom design trends. Multiple channel inserts are available including stainless steel, wood-optic for a calm and warm ambience and LED induction technology backlighting

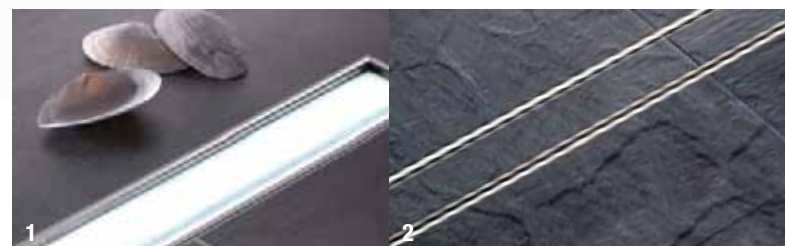



**SmartSelect** makes planning quite simply quicker - visit [smartselect.kessel.de](http://smartselect.kessel.de) for the configurator for alternative waterproofing layers in the system



Ideal for renovation

## Shower channels *Linearis Compact*

# *Linearis Compact* - compact shower channels

### OPTIMISED IN DESIGN AND FUNCTION

#### COMPLETE SHOWER CHANNELS

Ready-to-install complete shower channels with welded drain, minimum overall installation height 80 mm for bathroom renovation work. Flange installation height only 65 mm. Installation aid as accessory

#### LENGTHS

Nine channel lengths: 300, 450, 550, 650, 750, 850, 950, 1050 and 1150 mm.

#### TILEABLE

Stainless steel cover can be turned over and tiled to offer an "invisible" look.

#### CLEANING

Easy cleaning and maintenance thanks to simple removal of the channel rim using the removal mechanism (Fig. 3).



#### SOUND PROTECTION



Measurements carried out by the Fraunhofer Institute in Stuttgart: shower channel *Linearis Compact*

- $\geq 14$  dB(A) according to DIN 4109
- $\geq 10$  dB(A) according to VDI 4100 SST III



With its minimalist impression, the *Linearis Compact* shower channel fits in elegantly with a purist bathroom design.

Linearis Comfort			Products
Illustration and dimensioned drawing	Article description	Channel length	Article #
 <p>Installation supports and mesh fabric included</p>	<p><b>Shower channel Linearis Comfort</b>  <b>With drain body</b> in ABS, Ø 50, lateral outlet                      With removable odour trap, sealing water height 22 mm  <input type="checkbox"/> <b>cover and rim in stainless steel AISI 304</b>                      (Channel cover can be reversed and tiled on site), class K 3, with seeping water opening</p>	750 mm 850 mm 950 mm 1050 mm 1150 mm	45 600.83 45 600.84 45 600.85 45 600.86 45 600.87
	<p>1.0 l/sec flow rate without threshold,                      1.1 l/sec flow rate with 10 mm threshold</p>		
 <p>Installation supports and mesh fabric included</p>	<p><b>Shower channel Linearis Comfort Light</b>  <b>With drain body</b> in ABS, Ø 50, lateral outlet                      With removable odour trap, sealing water height 22 mm  <input type="checkbox"/> <b>cover with maintenance-free induction technology and "white" LED lights</b>                      (other colours available upon request), 15 m power cable, handles loads up to 100 kg, with seeping water opening</p>	750 mm 850 mm 950 mm 1150 mm	45 600.83 IC 45 600.84 IC 45 600.85 IC 45 600.87 IC
	<p>1.0 l/sec flow rate without threshold,                      1.1 l/sec flow rate with 10 mm threshold</p>		

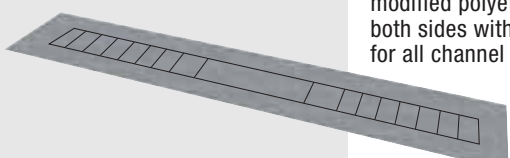
Linearis Comfort			Accessories
Illustration and dimensioned drawing	Article description	Channel length	Article #
 <p>Suitable for all channel lengths from 750 to 1150 mm</p> 	<p><b>Installation aid</b>                      Replaces the screed underlining                      Including mounting adhesive  <input type="checkbox"/> <b>Linearis Comfort</b>                      Suitable for all lengths, can be shortened on-site</p>	-	48 640
		<p><b>Collar seal</b>                      As a seal below the ceramic surfaces made of modified polyethylene membrane with fleece on both sides with printed cutting template suitable for all channel lengths                      Including mounting adhesive</p>	-

Installation example *Linearis Comfort*

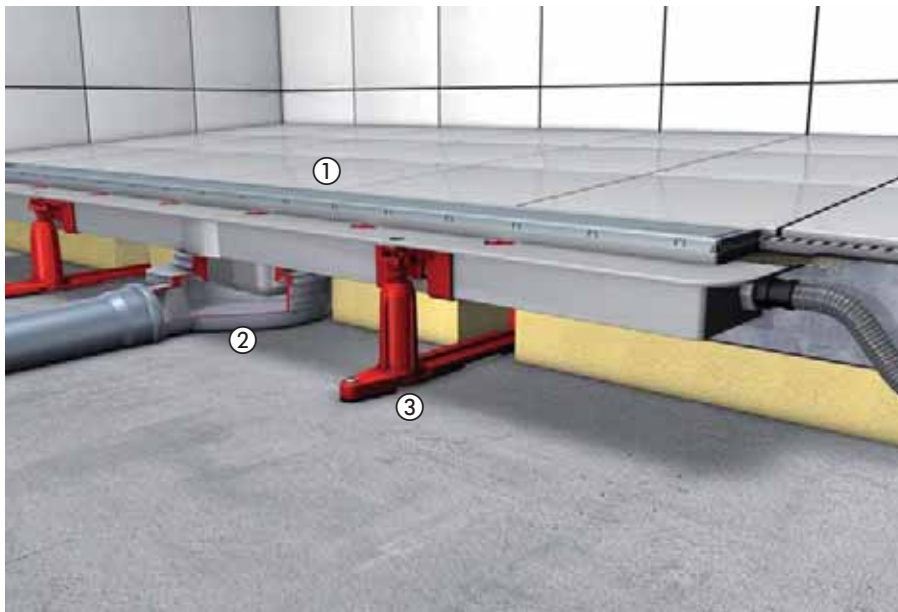

The *Linearis Comfort* shower channel effortlessly combines engineering and design to offer new and creative design concepts for your bathroom. The reversible channel cover ① can be displayed in the classic stainless steel look or reversed to show the invisible tiled look, also available are custom channel inserts such as wood optic and illuminated versions. The channels are ready-to-install with their welded on drain body ②, including an odour trap and  $\varnothing$  50 outlet. *Linearis Comfort* can be installed on the room or wall side of the shower. The flexible installation supports ③ are height-adjustable on the feet can be pivoted away as required for wall-side installation.

Professional advantages

- **Stainless steel cover is reversible and tileable**
- **Vertically adjustable frame**  
Stainless steel channel and rim can be adjusted from 7-22 mm to meet on site tile/granite/marble thicknesses.
- **Installation on room or wall side of shower**  
Feet can be pivoted away as required for wall-side installation.
- **Exemplary hygiene** - smooth, easy-clean surface, self-cleaning effect
- **Channel length:** 750 mm, 850 mm, 950 mm, 1050 mm, 1150 mm.
- **Channel locking mechanism as standard**
- **Flexible modular system** with a large number of design covers.
- **Hair filter and Multistop** - odour, foam, rodent and insect stop (**optional**)
- **1.1 l/sec flow rate with 10 mm threshold.**



■ Select, plan and visualize your own personalized KESSEL Design shower drainage system using the KESSEL Shower Drain Configurator at





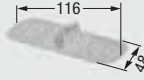

[www.kessel-design.com](http://www.kessel-design.com)

*Linearis Comfort*

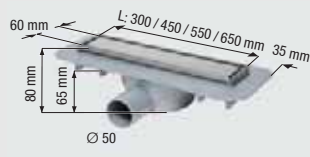
Accessories

Illustration and dimensioned drawing	Article description	Channel length	Article #
 Illustration shows ①	<b>Odour trap</b> ① sealing water height 22 mm ② sealing water height 50 mm only for shower channel <i>Linearis Compact</i> and <i>Linearis Comfort</i>	-	<b>48 603</b>
			-
	<b>Multistop</b> odour, foam, rodent and insect stop	-	<b>48 400</b>
	<b>Hair filter</b>	-	<b>48 800</b>

<i>Linearis Compact</i>			Products
Illustration and dimensioned drawing	Article description	Channel length	Article #
<p><b>Installation depth only 80 mm</b></p>  <p>Channel length from 300 to 650 mm</p>  <p>Channel length from 750 to 1150 mm</p> <p>Installation supports and mesh fabric included</p>	<p><b>Shower channel <i>Linearis Compact</i></b>  <b>With drain body</b> in ABS, Ø 50, lateral outlet            With removable odour trap, sealing water height 22 mm  <input type="checkbox"/> <b>cover and rim in stainless steel AISI 304</b>            (Channel cover can be reversed and tiled on site), class K 3, seeping water openings prepared</p>	300 mm 450 mm 550 mm 650 mm 750 mm 850 mm 950 mm 1050 mm 1150 mm	<b>45 600.59</b> <b>45 600.60</b> <b>45 600.61</b> <b>45 600.62</b> <b>45 600.63</b> <b>45 600.64</b> <b>45 600.65</b> <b>45 600.66</b> <b>45 600.67</b>
	<p>0.5 l/sec flow rate without threshold,            0.6 l/sec flow rate with 10 mm threshold</p>		

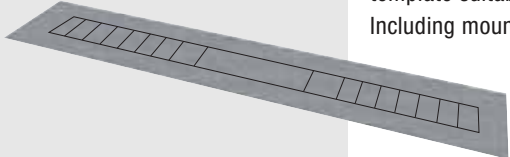
<i>Linearis Compact</i>			Accessories
Illustration and dimensioned drawing	Article description	Channel length	Article #
 <p><b>Example: Installation aid can be shortened on-site</b>            Suitable for all channel lengths from 300 to 1150 mm</p> 	<p><b>Installation aid</b>            Replaces the screed underlining            Including mounting adhesive</p> <p><input type="checkbox"/> <b><i>Linearis Compact</i></b>            Suitable for all lengths, can be shortened on-site</p>	-	<b>48 639</b>
	<p><b>Collar seal</b>            As a seal below the ceramic surfaces made of modified polyethylene membrane with fleece on both sides with printed cutting template suitable for all channel lengths            Including mounting adhesive</p>	-	<b>48 638</b>

Installation example *Linearis Compact*



Shower channels in a classic, timeless design. Minimalistic impression fits elegantly in a purist bathroom design. The finely finished channel surface in stainless steel ① can be reversed to offer a recessed side where the bathroom tile or natural stone surface can be installed. The channels are ready-to-install with their welded on drain body ②, including an odour trap and Ø 50 outlet. *Linearis Compact* can be installed on the room or wall side of the shower. The flexible installation supports ③ can be shortened for wall-side installation.

Professional advantages



- **Stainless steel cover is reversible and tileable**
- **Installation in the room or on the wall**  
The length of the feet can be shortened on the left or right if mounted to the wall.
- **Hygienic design** - single piece body and channel cover
- **Channel length:** 300 mm, 450 mm, 550 mm, 650 mm, 750 mm, 850 mm, 950 mm, 1050 mm, 1150 mm.
- **Flow rate** with counter slope **up to 0.6 l/sec with 10 mm threshold. Flow rate increased to 0.9 l/sec** with use of **Multistop** odour trap.
- **Cover and rim** made of stainless steel.
- **Multistop (optional)** - odour, foam, rodent and insect stop
- **Hair filter (optional)**



**SmartSelect** makes planning quite simply quicker - visit [smartselect.kessel.de](http://smartselect.kessel.de) for the configurator for alternative waterproofing layers in the system

*Linearis Compact*

Accessories

Illustration and dimensioned drawing	Article description	Channel length	Article #
 Illustration shows ①	<b>Odour trap</b>		
	① sealing water height 22 mm ② sealing water height 50 mm only for shower channel <i>Linearis Compact</i> and <i>Linearis Comfort</i>	-	<b>48 603</b>
	<b>Multistop</b> odour, foam, rodent and insect stop	-	<b>48 400</b>
	<b>Hair filter</b>	-	<b>48 800</b>

# Shower channel *Linearis Comfort* System 125

## Shower channel upper section *Linearis Comfort*

1.0 l/sec flow rate  
1.1 l/sec with 10 mm threshold



### *Linearis Comfort* in ABS

With removable odour trap, sealing water height 50 mm

- cover and rim in stainless steel AISI 304**  
(Channel cover can be reversed and tiled on site),  
class K 3, with seeping water opening,  
installation supports and mesh fabric

Length	Art. #
750 mm	<b>48 928 S</b>
850 mm	<b>48 929 S</b>
950 mm	<b>48 930 S</b>
1050 mm	<b>48 931 S</b>
1150 mm	<b>48 932 S</b>

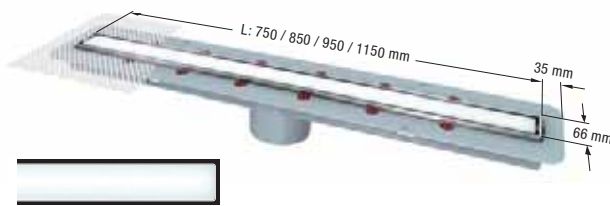

### *Linearis Comfort Light* in ABS

With removable odour trap, sealing water height 50 mm

- cover with maintenance-free induction technology and "white" LED lights** (other colours available upon request), 15 m power cable, handles loads up to 100 kg, with seeping water opening, installation supports and mesh fabric

750 mm	<b>48 928 IC</b>
850 mm	<b>48 929 IC</b>
950 mm	<b>48 930 IC</b>
1150 mm	<b>48 932 IC</b>

Minimum installation depth of upper section (without drain body) 46 mm

## Accessories

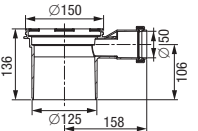
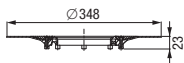

### Glue flange

with counter flange,  $\varnothing$  348 mm  
(also for compound seal)  
Art. # **48 410**

### Pressure sealing flange

in stainless steel AISI 304,  $\varnothing$  273 mm,  
with seeping water opening  
Art. # **48 402**

### Extension section

in PP, with lip seal  
without lateral inlet Art. # **48 987**  
with lateral inlet Art. # **48 989**

## Drain bodies

Total installation height including upper section

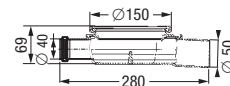
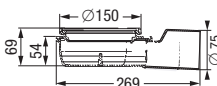
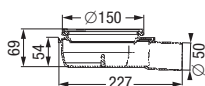
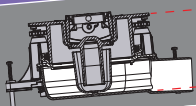

### "The Ultraflat" in ABS

with removable odour trap  
Lateral outlet  $\varnothing$  50  
Art. # **45 700**

Lateral outlet  $\varnothing$  75  
Art. # **45 770**

### "The Ultraflat" in ABS

with removable odour trap  
with lateral inlet  $\varnothing$  40,  
lateral outlet  $\varnothing$  50  
Art. # **45 701**

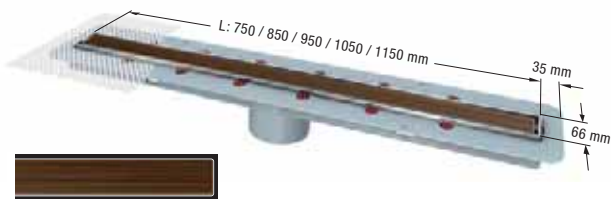

### Linearis Comfort "Wengé" in ABS

With removable odour trap, sealing water height 50 mm

- Cover in wood look,** handles loads up to 100 kg, with seeping water opening, installation supports and mesh fabric

Length	Art. #
750 mm	on request
850 mm	on request
950 mm	on request
1050 mm	on request
1150 mm	on request

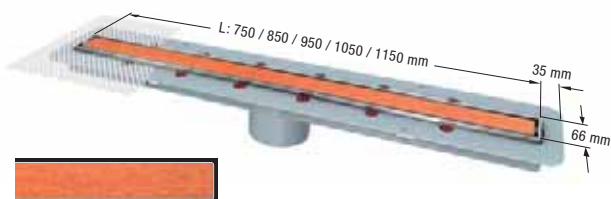

### Linearis Comfort "Burlwood" in ABS

With removable odour trap, sealing water height 50 mm

- Cover in wood look,** handles loads up to 100 kg, with seeping water opening, installation supports and mesh fabric

750 mm	on request
850 mm	on request
950 mm	on request
1050 mm	on request
1150 mm	on request

Minimum installation depth of upper section (without drain body) 46 mm

\* Approval pending on the basis of test certificate no. 210006415 MPA Erwitte.



#### Multistop

odour, foam, rodent and insect stop  
Art. # 48 400

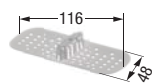

#### Hair filter

made of polymer  
Art. # 48 800



#### Fire-Kit Fire protection insert\*

Only for *Ecoguss/ Practicus* drains with vertical outlet and odour trap

- Ø 58/78/83 Art. # 48 099
- Ø 50/75 Art. # 48 099
- Ø 110 Art. # 48 100



#### Quick-Fit the passage seal

for core drillings for drain bodies with vertical outlet

- without fire protection** Art. # 48 991
- \*with fire protection** Art. # 48 990 (only in combination with *Fire-Kit* protection insert)

The *Linearis Comfort* shower channel inserts already include an odour trap. For this reason, the odour trap must be removed from all drain bodies during installation.



#### Ecoguss

with removable odour trap

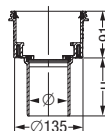
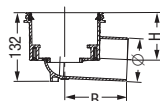

#### Practicus in PP

with removable odour trap



Lateral outlet			Vertical outlet		
Ø	B	H	Article #	H	Article #
58	245	120	48 358	100	48 458
78	134	109	48 378	110	48 478
83	134	108	48 383	110	48 483
110	148	92	48 311	110	48 411

Lateral outlet			Vertical outlet		
Ø	B	H	Article #	H	Article #
50	245	120	45 150	100	45 250
75	134	109	45 170	110	45 270
110	148	92	45 110	110	45 210

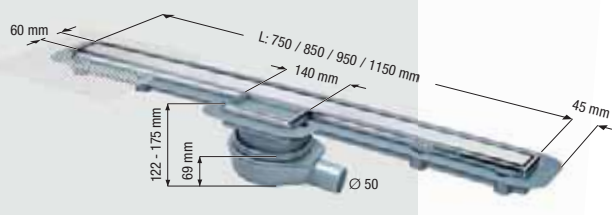
<i>Linearis Super60</i>			Products
Illustration and dimensioned drawing	Article description	Channel length	Article #
	<p><b>Shower channel <i>Linearis Super60</i> in ABS with tileable access cover</b>  <b>With bathroom drain body “The Ultraflat”</b>                      in ABS, Ø 50, lateral outlet                      With removable odour trap, sealing water height 30 mm  <input type="checkbox"/> <b>cover and rim in stainless steel AISI 304</b>                      (Channel cover can be reversed and tiled on site), class K 3, with seeping water opening</p>	750 mm	<b>45 700.83</b>
		850 mm	<b>45 700.84</b>
		950 mm	<b>45 700.85</b>
		1150 mm	<b>45 700.87</b>
Installation supports and mesh fabric included	1.1 l/sec flow rate without threshold, 1.2 l/sec flow rate with 10 mm threshold		

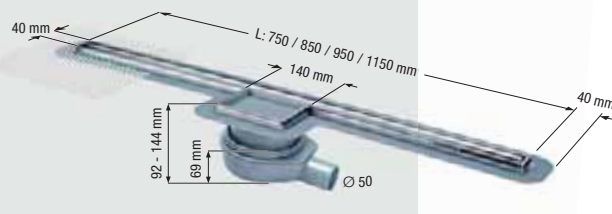
<i>Linearis</i>			Products
Illustration and dimensioned drawing	Article description	Channel length	Article #
	<p><b>Shower channel <i>Linearis</i> in ABS with tileable access cover</b>  <b>With bathroom drain body “The Ultraflat”</b>                      in ABS, Ø 50, lateral outlet                      With removable odour trap, sealing water height 30 mm  <input type="checkbox"/> <b>cover and rim in stainless steel AISI 304</b>                      class K 3, with seeping water opening</p>	750 mm	<b>45 700.73</b>
		850 mm	<b>45 700.74</b>
		950 mm	<b>45 700.75</b>
		1150 mm	<b>45 700.77</b>
Installation supports and mesh fabric included	0.4 l/sec flow rate with 10 mm threshold		

Installation example *Linearis Super60*

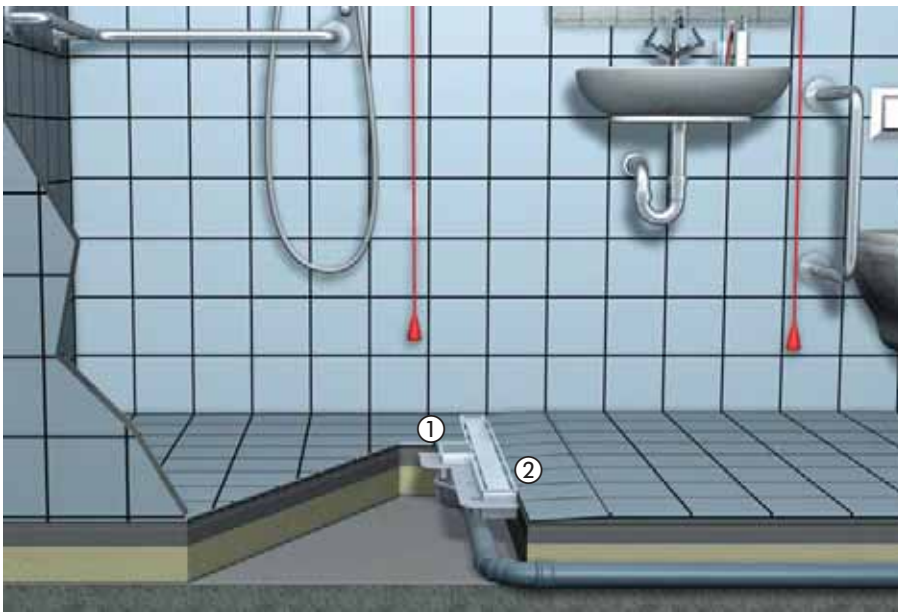

The *Linearis Super60* shower channels offers a very high flow rate of 72 liters per minute making it perfect for use in higher flow applications. The *Linearis Super60* also allows full service access to the odor trap and drain body via the removable channel and access cover ① for cleaning and maintenance purposes. The attractive stainless steel channel ② can also be reversed revealing a recessed area which can be tiled to also offer the “invisible” tiled look. One channel with your choice of two styles - stainless or invisible.

Installation example *Linearis*



The *Linearis* shower channel features a narrow, elegant stainless steel channel ① which can be discreetly integrated into the bathroom design. With a flow capacity of 24 liters per minute the *Linearis* shower channel is ideal for mounting against the wall at the back of the shower. For cleaning and maintenance purposes the stainless steel channel and tileable access cover ② can be removed allowing full access to the odor trap and drain body.

Professional advantages

- **Wide channel with high flow rate from 1.1 - 1.2 l/sec**
- **Easy cleaning**  
Access cover for easy cleaning and maintenance
- **Channel cover can be reversed and tiled on site**
- **Channel length:** 750 mm, 850 mm, 950 mm, 1150 mm
- **Also suitable for installation on door side**
- **Flexible modular system** with a large number of components.



**SmartSelect** makes planning quite simply quicker - visit [smartselect.kessel.de](http://smartselect.kessel.de) for the configurator for alternative waterproofing layers in the system

Professional advantages

- **Flow rate 0.4 l/sec**
- **Extremely narrow and elegant channel**
- **Easy cleaning**  
Access cover for easy cleaning and maintenance
- **Particularly suitable** for installation on the wall side
- **Channel length:** 750 mm, 850 mm, 950 mm, 1150 mm
- **Flexible modular system** with a large number of components.



**SmartSelect** makes planning quite simply quicker - visit [smartselect.kessel.de](http://smartselect.kessel.de) for the configurator for alternative waterproofing layers in the system

# Shower channel *Linearis Super60* and *Linearis* System 125

## Shower channel upper section *Linearis Super60*

1.1 l/sec flow rate  
1.2 l/sec with 10 mm threshold

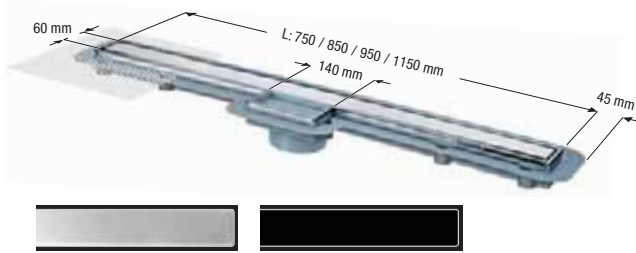

**Linearis Super60** in ABS  
with tileable access cover

cover and rim in stainless steel AISI 304 (Channel cover can be reversed and tiled on site), class K 3, with seeping water opening, installation supports and mesh fabric

Length	Art. #
750 mm	<b>48 908</b>
850 mm	<b>48 909</b>
950 mm	<b>48 910</b>
1150 mm	<b>48 912</b>

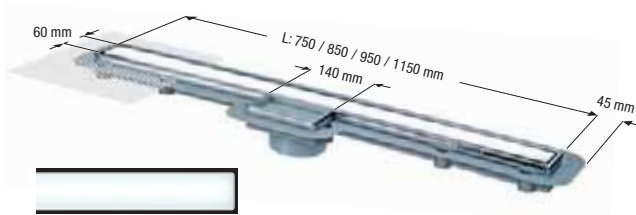

**Linearis Super60 Light** in ABS  
with tileable access cover

cover with maintenance-free induction technology and "white" LED lights (other colours available upon request), 15 m power cable, handles loads up to 100 kg, with seeping water opening, installation supports and mesh fabric

750 mm	<b>48 908 IC</b>
850 mm	<b>48 909 IC</b>
950 mm	<b>48 910 IC</b>
1150 mm	<b>48 912 IC</b>

Minimum installation depth of upper section (without drain body) 46 mm

## Shower channel upper section *Linearis*

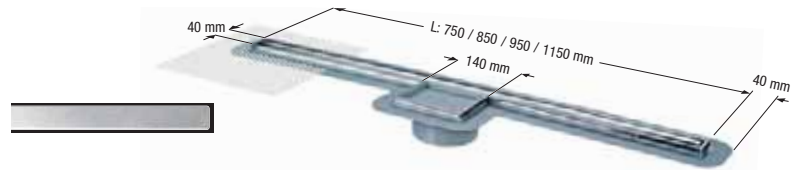

## Accessories

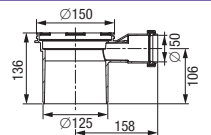
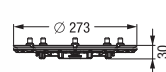
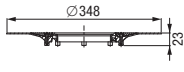

### Glue flange

with counter flange,  $\varnothing$  348 mm (also for compound seal)  
Art. # **48 410**

### Pressure sealing flange

in stainless steel AISI 304,  $\varnothing$  273 mm, with seeping water opening  
Art. # **48 402**

### Extension section

in PP, with lip seal  
without lateral inlet  $\varnothing$  50 Art. # **48 987**  
with lateral inlet  $\varnothing$  50 Art. # **48 989**

## Drain bodies

1.0 l/sec flow rate  
Sealing water height 30 mm

1.0 l/sec flow rate  
Sealing water height 30 mm

1.2 l/sec flow rate  
Sealing water height 50 mm

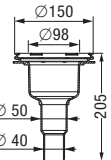
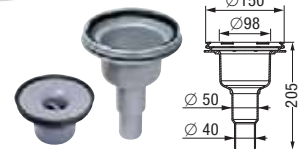
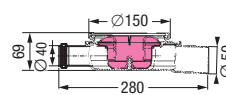
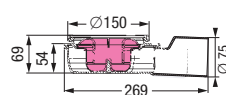
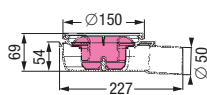

### "The Ultraflat" in ABS

with removable odour trap  
Lateral outlet  $\varnothing$  50  
Art. # **45 700**

Lateral outlet  $\varnothing$  75  
Art. # **45 770**

### "The Ultraflat" in ABS

with removable odour trap  
with lateral inlet  $\varnothing$  40,  
lateral outlet  $\varnothing$  50  
Art. # **45 701**

### "The Vertical" in ABS

Vertical outlet  $\varnothing$  50/40  
with removable odour trap  
fits all upper sections System 125  
Art. # **45 254**

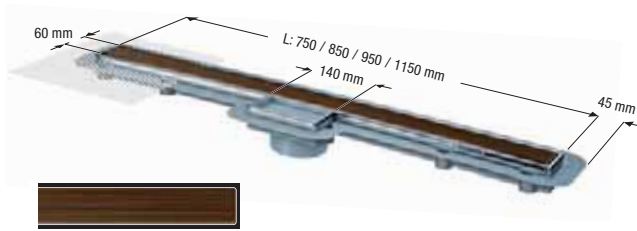

**Linearis Super60 "Wengé" in ABS with tileable access cover**  
 **Cover in wood look**, handles loads up to 100 kg, with seeping water opening, installation supports and mesh fabric

Length	Art. #
750 mm	<b>48 908 IW</b>
850 mm	<b>48 909 IW</b>
950 mm	<b>48 910 IW</b>
1150 mm	<b>48 912 IW</b>

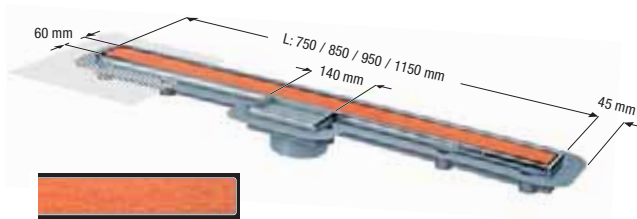

**Linearis Super60 "Burlwood" in ABS with tileable access cover**  
 **Cover in wood look**, handles loads up to 100 kg, with seeping water opening, installation supports and mesh fabric

750 mm	<b>48 908 IH</b>
850 mm	<b>48 909 IH</b>
950 mm	<b>48 910 IH</b>
1150 mm	<b>48 912 IH</b>

Minimum installation depth of upper section (without drain body) 46 mm

**Linearis in ABS with tileable access cover**  
 **cover and rim in stainless steel AISI 304**, class K 3, with seeping water opening, installation supports and mesh fabric  
 0.4 l/sec flow rate with 10 mm threshold

Length	Art. #
750 mm	<b>46 908</b>
850 mm	<b>46 909</b>
950 mm	<b>46 910</b>
1150 mm	<b>46 912</b>



### Multistop

odour, foam, rodent and insect stop  
 Art. # **48 500**



### Hair filter

made of polymer  
 Art. # **48 700**

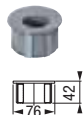

### Fire-Kit Fire protection insert

Only for *Ecoguss* / *Practicus* drains with vertical outlet and odour trap  
 Certification no. Z-19.17-1719  
 Ø 58/78/83 Art. # **48 099**  
 Ø 50/75 Art. # **48 099**  
 Ø 110 Art. # **48 100**



### Quick-Fit the passage seal

for core drillings for drain bodies *Ecoguss* and *Practicus*, with vertical outlet  
 Certification no. Z-19.17-1719  
**without fire protection** Art. # **48 991**  
**\*with fire protection** Art. # **48 990**  
 (only in combination with *Fire-Kit* protection insert)

All drain bodies:  
 1.8 l/sec flow rate  
 Sealing water height 50 mm

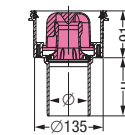
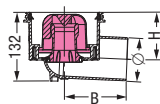

### Ecoguss

with removable odour trap

Lateral outlet				Vertical outlet	
Ø	B	H	Article #	H	Article #
<b>58</b>	245	120	<b>48 358</b>	100	<b>48 458</b>
<b>78</b>	134	109	<b>48 378</b>	110	<b>48 478</b>
<b>83</b>	134	108	<b>48 383</b>	110	<b>48 483</b>
<b>110</b>	148	92	<b>48 311</b>	110	<b>48 411</b>

### Practicus in PP

with removable odour trap

Lateral outlet				Vertical outlet	
Ø	B	H	Article #	H	Article #
<b>50</b>	245	120	<b>45 150</b>	100	<b>45 250</b>
<b>75</b>	134	109	<b>45 170</b>	110	<b>45 270</b>
<b>110</b>	148	92	<b>45 110</b>	110	<b>45 210</b>

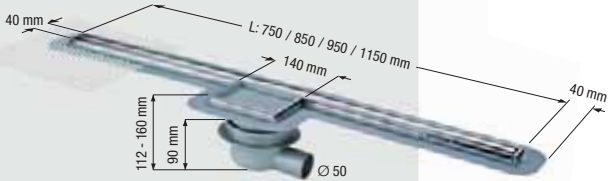
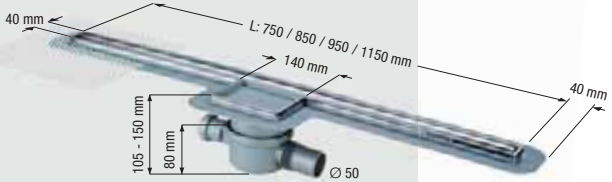
Linearis		Products	
Illustration and dimensioned drawing	Article description	Channel length	Article #
 <p>Installation supports and mesh fabric included</p>	<p><b>Shower channel <i>Linearis</i></b> in ABS <b>with tileable access cover</b> <b>With bathroom drain body <i>Classic</i></b> in ABS, Ø 50, lateral outlet</p> <p><input type="checkbox"/> <b>cover and rim in stainless steel AISI 304,</b> class K 3, with seeping water opening</p> <p>0.4 l/sec flow rate with 10 mm threshold</p>	<p>750 mm 850 mm 950 mm 1150 mm</p>	<p><b>40 150.83</b> <b>40 150.84</b> <b>40 150.85</b> <b>40 150.87</b></p>
 <p>Installation supports and mesh fabric included</p>	<p><b>Shower channel <i>Linearis</i></b> in ABS <b>with tileable access cover</b> <b>With bathroom drain body "<i>The Superflat</i>"</b> in PP, sound-absorbing, Ø 50, flexible lateral outlet, 1 inlet Ø 40</p> <p><input type="checkbox"/> <b>cover and rim in stainless steel AISI 304,</b> class K 3, with seeping water opening</p> <p>0.4 l/sec flow rate with 10 mm threshold</p>	<p>750 mm 850 mm 950 mm 1150 mm</p>	<p><b>42 701.83</b> <b>42 701.84</b> <b>42 701.85</b> <b>42 701.87</b></p>

#### Installation example *Linearis*



The *Linearis* shower channel features a narrow, elegant stainless steel channel ① which can be discreetly integrated into the bathroom design. With a flow capacity of 24 liters per minute the *Linearis* shower channel is ideal for mounting against the wall at the back of the shower. For cleaning and maintenance purposes the stainless steel channel and tileable access opening ② can be removed allowing full access to the odor trap and drain body.

#### Professional advantages

- **Flow rate 0.4 l/sec**
- **Extremely narrow and elegant channel**
- **Easy cleaning**  
Access cover for easy cleaning and maintenance
- **Particularly suitable** for installation on the wall side
- **Channel length:** 750 mm, 850 mm, 950 mm, 1150 mm
- **Flexible modular system** with a large number of components.



**SmartSelect** makes planning quite simply quicker - visit [smartselect.kessel.de](https://smartselect.kessel.de) for the configurator for alternative waterproofing layers in the system

Shower channel upper section *Linearis*

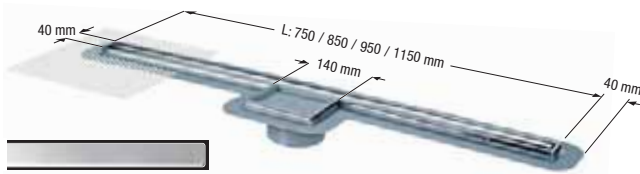

**Linearis** in ABS  
with tileable access cover  
 cover and rim in stainless steel AISI 304, class K 3, with seeping water opening, installation supports and mesh fabric

Length	Art. #
750 mm	27 808
850 mm	27 809
950 mm	27 810
1150 mm	27 812

0.4 l/sec flow rate with 10 mm threshold

Accessories

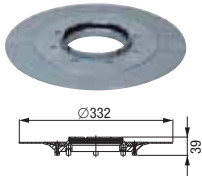

**Glue flange**  
with counter flange  
(also for compound seal)  
Art. # 43 401

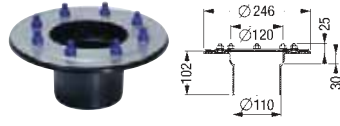

**Extension section**  
in PP, with pressure sealing flange in stainless steel AISI 304, flange width 63 mm  
Art. # 27 198

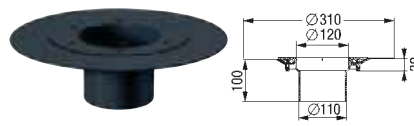

**Extension section**  
in ABS, with glue flange and counter flange  
Art. # 27 199

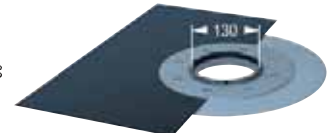

**With glue flange and waterproof membrane**  
pre-mounted in PVC  
1200 x 1200 mm Art. # 43 401.91  
1800 x 2000 mm Art. # 43 401.93

**Waterproof membrane** in PVC without punched-out hole  
1800 x 2000 mm Art. # 43 711

**Glue**  
Art. # 43 719

**Elastomer waterproof membrane**  500 mm

in PVC Art. # 43 710  
in EPDM Art. # 43 730

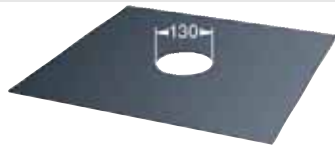

The waterproof membrane in PVC and EPDM are not suitable for connections to asphalt sheeting.

Shower channels

4

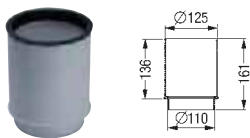

**Extension section**  
in ABS, with lip seal  
Art. # 27 146

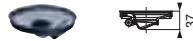

**Multistop**  
odour, foam, rodent and insect stop  
Art. # 43 500



**Hair filter**  
made of polymer, Ø 108 mm  
Art. # 43 700



**Transition section**  
with sealing ring Ø 50  
Ø 50/75 Art. # 27 126  
Ø 50/40 Art. # 27 118

Drain bodies

\*) according to EN 1253 - 20 mm threshold

0.8 l/sec flow rate \*)  
Sealing water height 50 mm

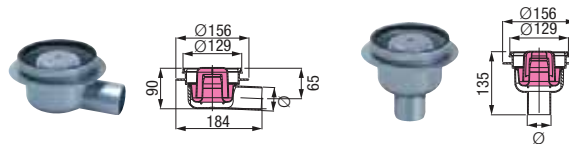

Bathroom drain *Classic* in ABS

with removable odour trap		
Ø	Lateral outlet	Vertical outlet
50	Art. # 40 150	Art. # 40 250
75	Art. # 40 170	Art. # 40 270

without removable odour trap		
Ø	Lateral outlet	Vertical outlet
50	Art. # 40 151	Art. # 40 251
75	Art. # 40 171	Art. # 40 271

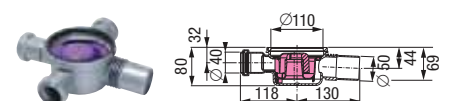
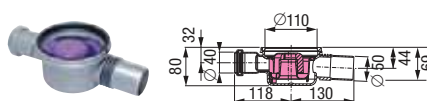
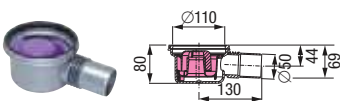

Bathroom drain *"The Superflat"* in PP

Lateral outlet Ø 50, with removable odour trap  
Without lateral inlet  
Art. # 42 700

One lateral inlet Ø 40  
Art. # 42 701

Three lateral inlets Ø 40  
Art. # 42 703

0.8 l/sec flow rate \*)  
Sealing water height 30 mm